

18. BATTERY/CHARGING SYSTEM

SYSTEM DIAGRAM.....	18-2	CHARGING SYSTEM INSPECTION.....	18-7
SERVICE INFORMATION	18-3	ALTERNATOR CHARGING COIL	18-8
TROUBLESHOOTING	18-5	REGULATOR/RECTIFIER	18-8
BATTERY.....	18-6		

BATTERY/CHARGING SYSTEM

SYSTEM DIAGRAM

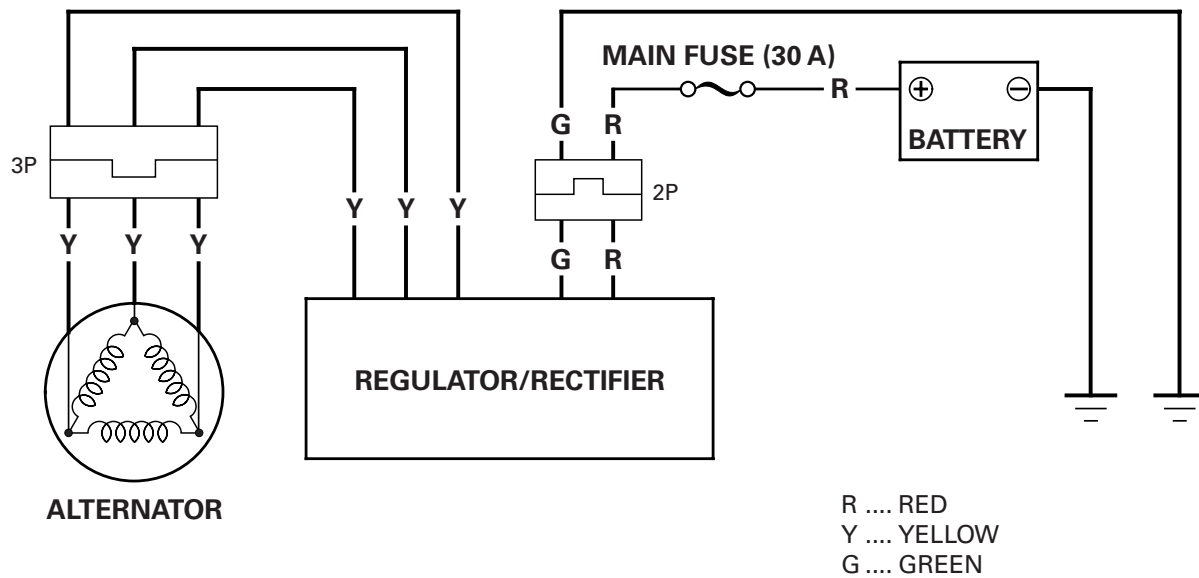
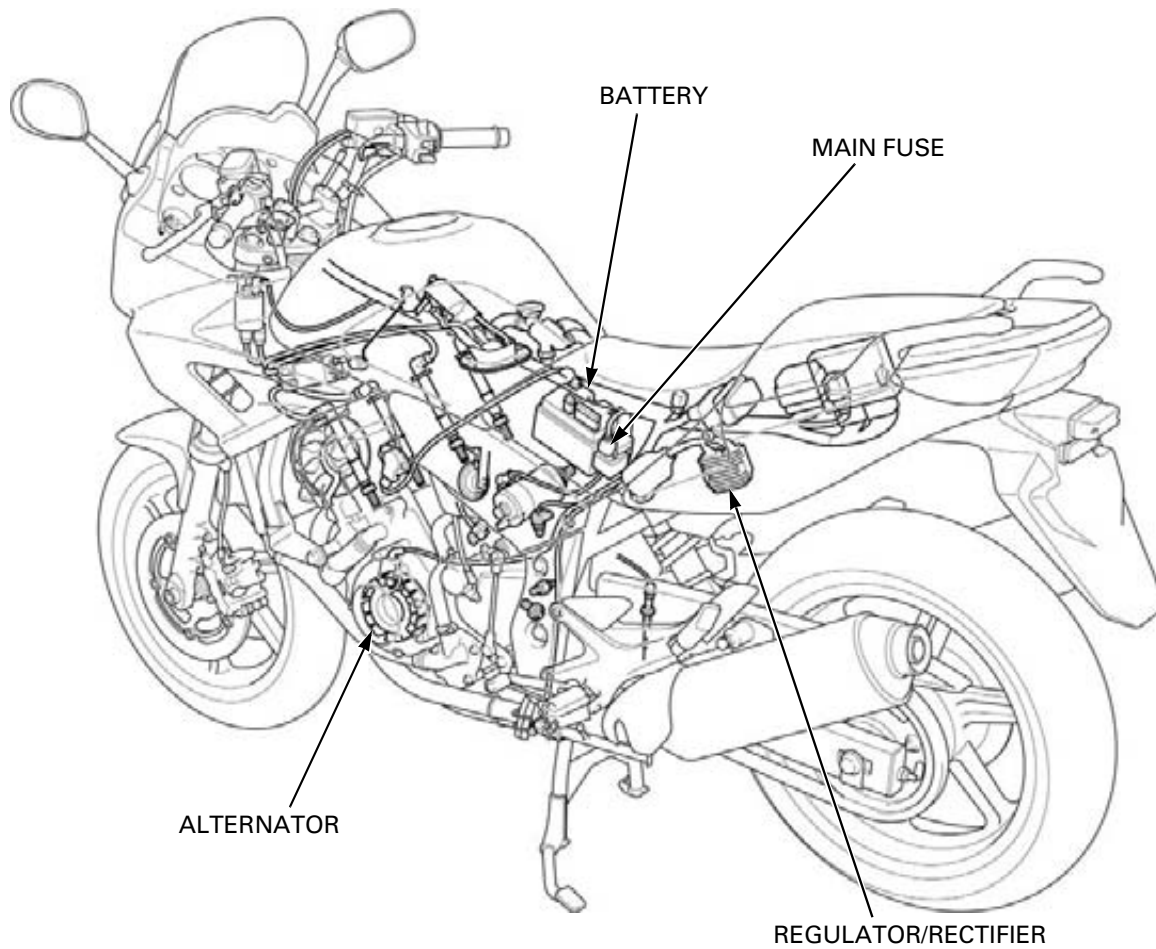

SERVICE INFORMATION

GENERAL

⚠ WARNING

- The battery gives off explosive gases; keep sparks, flames and cigarettes away. Provide adequate ventilation when charging.
- The battery contains sulfuric acid (electrolyte). Contact with skin or eyes may cause severe burns. Wear protective clothing and a face shield.
 - If electrolyte gets on your skin, flush with water.
 - If electrolyte gets in your eyes, flush with water for at least 15 minutes and call a physician immediately.
- Electrolyte is poisonous.
 - If swallowed, drink large quantities of water or milk and call your local Poison Control Center or call a physician immediately.

NOTICE

- *Always turn off the ignition switch before disconnecting any electrical component.*
- *Some electrical components may be damaged if terminals or connectors are connected or disconnected while the ignition switch is ON and current is present.*
- This model comes with a maintenance free (MF) battery. The maintenance free battery must be replaced when it reaches the end of its service life.
- For extended storage, remove the battery, give it a full charge, and store it in a cool, dry space. For maximum service life, charge the stored battery every two weeks.
- For a battery remaining in a stored motorcycle, disconnect the negative battery cable from the battery terminal.
- The battery can be damaged if overcharged or undercharged, or if left to discharge for a long period. These same conditions contribute to shortening the "life span" of the battery. Even under normal use, the performance of the battery deteriorates after 2 – 3 years.
- Battery voltage may recover after battery charging, but under heavy load, battery voltage will drop quickly and eventually die out. For this reason, the charging system is often suspected as the problem. Battery overcharge often results from problems in the battery itself, which may appear to be an overcharging symptom. If one of the battery cells is shorted and battery voltage does not increase, the regulator/rectifier supplies excess voltage to the battery. Under these conditions, the electrolyte level goes down quickly.
- Before troubleshooting the charging system, check for proper use and maintenance of the battery. Check if the battery is frequently under heavy load, such as having the headlight and taillight ON for long periods of time without riding the motorcycle.
- The battery will self-discharge when the motorcycle is not in use. For this reason, charge the battery every two weeks to prevent sulfation from occurring.
- When checking the charging system, always follow the steps in the troubleshooting flow chart (page 18-5).
- Refer to procedures for alternator removal and disassembly (page 11-3).

BATTERY CHARGING

- Turn power ON/OFF at the charger, not at the battery terminal.
- For battery charging, do not exceed the charging current and time specified on the battery. Using excessive current or extending the charging time may damage the battery.
- Quick charging should only be done in an emergency; slow charging is preferred.

BATTERY TESTING

Refer to the instructions in the Operation Manual for the recommended battery tester for details about battery testing. The recommended battery tester puts a "load" on the battery so that the actual battery condition can be measured.

Recommended battery tester: BM-210 or BATTERY MATE or equivalent

BATTERY/CHARGING SYSTEM

SPECIFICATIONS

ITEM		SPECIFICATIONS	
Battery	Capacity	12 V – 8.6 Ah	
	Current leakage	0.5 mA max.	
	Voltage (20°C/68°F)	Fully charged	13.0 – 13.2 V
		Needs charging	Below 12.4 V
	Charging current	Normal	0.9 A/5 – 10 h
Quick		4.5 A/1 h	
Alternator	Capacity	0.344 kW/5,000 min ⁻¹ (rpm)	
	Charging coil resistance (20°C/68°F)	0.1 – 1.0 Ω	

TROUBLESHOOTING

BATTERY IS DAMAGED OR WEAK

1. BATTERY TEST

Remove the battery (page 18-6).

Check the battery condition using the recommended battery tester.

RECOMMENDED BATTERY TESTER: BM210 or BATTERY MATE or equivalent

Is the battery in good condition?

NO – Faulty battery

YES – GO TO STEP 2.

2. CURRENT LEAKAGE TEST

Install the battery (page 18-6).

Check the battery current leakage (page 18-7).

Is the current leakage below 0.5 mA?

YES – GO TO STEP 4.

NO – GO TO STEP 3.

3. CURRENT LEAKAGE TEST WITHOUT REGULATOR/RECTIFIER CONNECTED

Disconnect the regulator/rectifier 2P connector and recheck the battery current leakage.

Is the current leakage below 0.5 mA?

YES – Faulty regulator/rectifier

NO –

- Shorted wire harness
- Faulty ignition switch

4. ALTERNATOR CHARGING COIL INSPECTION

Check the alternator charging coil (page 18-8).

Is the alternator charging coil resistance within 0.1 – 1.0 Ω (20°C/68°F)?

NO – Faulty charging coil

YES – GO TO STEP 5.

5. CHARGING VOLTAGE INSPECTION

Measure and record the battery voltage using a digital multimeter (page 18-6).

Start the engine and measure the charging voltage (page 18-7).

Compare the measurements to result of the following calculation.

STANDARD: Measured BV < Measured CV < 15.5 V

· **BV = Battery Voltage (page 18-6)**

· **CV = Charging Voltage**

Is the measured charging voltage within the standard voltage?

YES – Faulty battery

NO – GO TO STEP 6.

6. REGULATOR/RECTIFIER SYSTEM INSPECTION

Check the voltage at the regulator/rectifier connector (page 18-8).

Are the results of checked voltage correct?

YES – Faulty regulator/rectifier

NO –

- Open circuit in related wire
- Loose or poor contacts of related terminal
- Shorted wire harness

BATTERY/CHARGING SYSTEM

BATTERY

REMOVAL/INSTALLATION

- Always turn the ignition switch OFF before removing the battery.

Remove the right side cover (page 3-4).

CBF1000A only: Remove the ABS/FI fuse box.

Disconnect the negative cable first, then the positive cable.

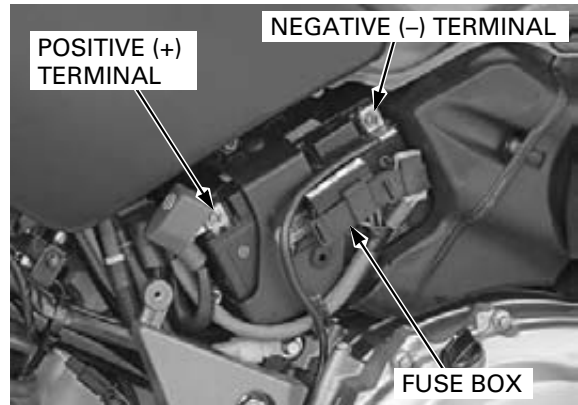

Remove the battery bracket mounting bolts, and then remove the battery with the bracket.

Connect the positive cable first and then the negative cable.

Install the battery in the reverse order of removal. After installing the battery, coat the terminals with clean grease.

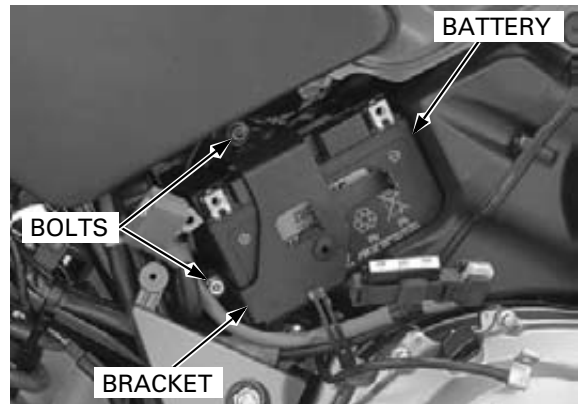

VOLTAGE INSPECTION

Measure the battery voltage using a digital multimeter.

VOLTAGE:

Fully charged: 13.0 – 13.2V

Under charged: Below 12.3V

TOOL:

Digital multimeter

Commercially available

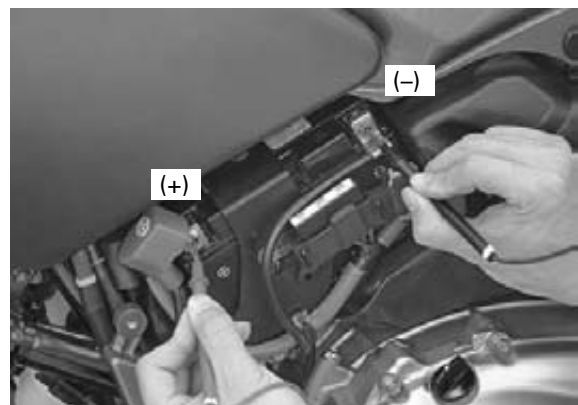

CHARGING SYSTEM INSPECTION

CURRENT LEAKAGE INSPECTION

Remove the right side cover (page 3-4).

Do not disconnect the battery or any cable in the charging system without first switching off the ignition switch. Failure to follow this precaution can damage the tester or electrical components.

Turn the ignition switch OFF and disconnect the battery negative cable from the battery.

Connect the ammeter (+) probe to the negative cable and the ammeter (-) probe to the battery (-) terminal.

With the ignition switch OFF, check for current leakage.

- When measuring current using a tester, set it to a high range, and then bring the range down to an appropriate level. Current flow higher than the range selected may blow out the fuse in the tester.
- While measuring current, do not turn the ignition switch ON. A sudden surge of current may blow out the fuse in the tester.

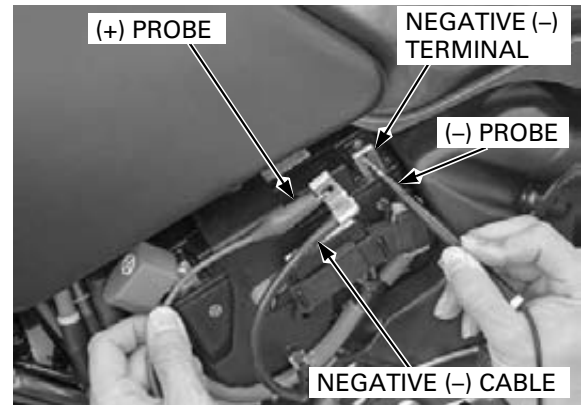

SPECIFIED CURRENT LEAKAGE: 0.5 mA max.

If current leakage exceeds the specified value, a shorted circuit is likely.

Locate the short by disconnecting connections one by one and measuring the current.

CHARGING VOLTAGE INSPECTION

Be sure the battery is in good condition before performing this test.

Warm up the engine to normal operating temperature.

Stop the engine, and connect the multimeter between the positive and negative terminals of the battery.

NOTE:

To prevent a short, make absolutely certain which are the positive and negative terminals or cable.

Restart the engine.

With the headlight on Hi beam, measure the voltage on the multimeter when the engine runs at 5,000 min^{-1} (rpm).

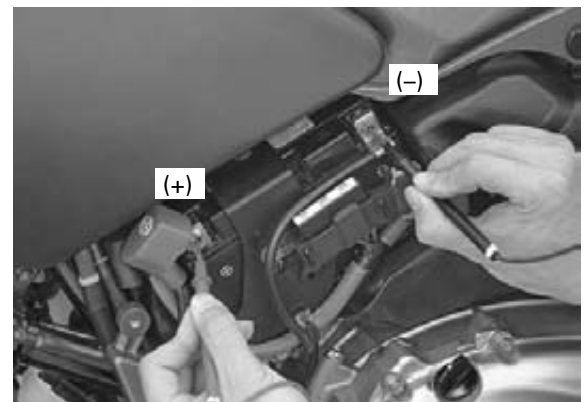

STANDARD:

Measured BV < Measured CV < 15.5 V

- BV = Battery Voltage (page 18-6)
- CV = Charging Voltage

BATTERY/CHARGING SYSTEM

ALTERNATOR CHARGING COIL

INSPECTION

- It is not necessary to remove the stator coil to make this test.

Remove the following:

- Left side cover (page 3-4)
- Left rear cowl (page 3-8)

Remove the wire band and disconnect the alternator 3P (White) connector.

Check the resistance between three Yellow terminals of the alternator side connector.

STANDARD: 0.1 – 1.0 Ω (at 20°C/68°F)

Check for continuity between each terminal and ground.

There should be no continuity.

If resistance is out of specification, or if any wire has continuity to ground, replace the alternator stator. Refer to procedure for stator removal (page 11-6).

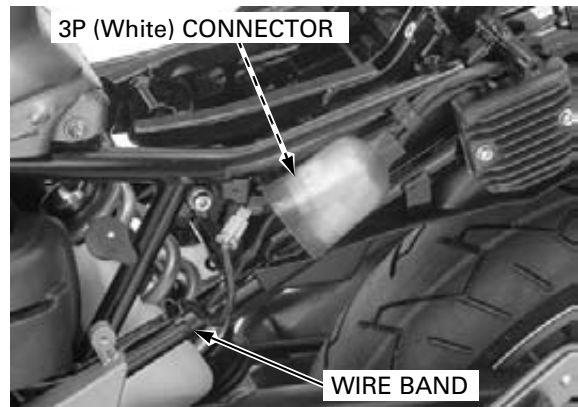

REGULATOR/RECTIFIER

WIRE HARNESS INSPECTION

Remove the following:

- Left side cover (page 3-4)
- Left rear cowl (page 3-8)

Remove the wire band and disconnect the regulator/rectifier 2P connector and alternator 3P (White) connector.

Check the connectors for loose contacts or corroded terminals.

If the regulated voltage reading (page 18-7) is out of the specification, check the following at the wire harness side connector.

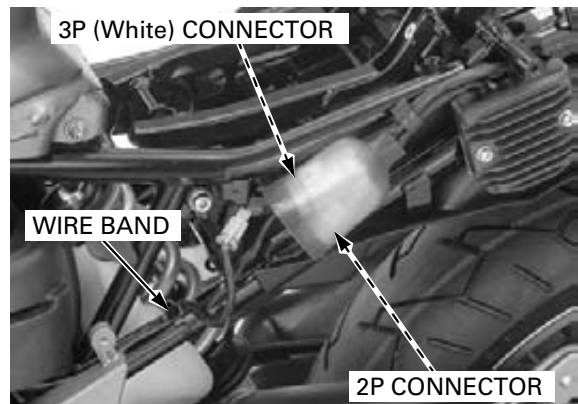

BATTERY LINE:

Measure the voltage between the red wire terminal and green wire terminal.

There should be battery voltage at all time.

GROUND LINE:

Check the continuity between the green wire terminal and ground.

There should be continuity at all time.

If all components of the charging system are normal and there are no loose connections at the regulator/rectifier connectors, replace the regulator/rectifier (page 18-9).

REGULATOR/RECTIFIER 2P CONNECTOR
(Wire side of female terminals):

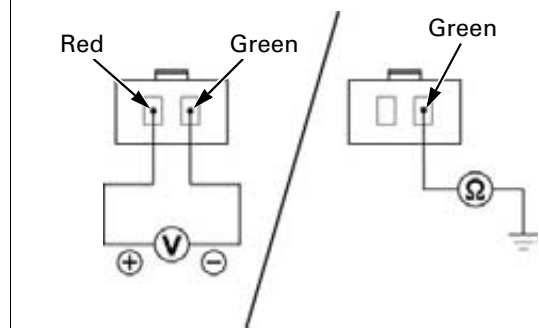

REMOVAL/INSTALLATION

Remove the left rear cowl (page 3-8).

Disconnect the alternator 3P (White) connector and regulator/rectifier 2P connector.

Release the regulator/rectifier wire from the harness clamp.

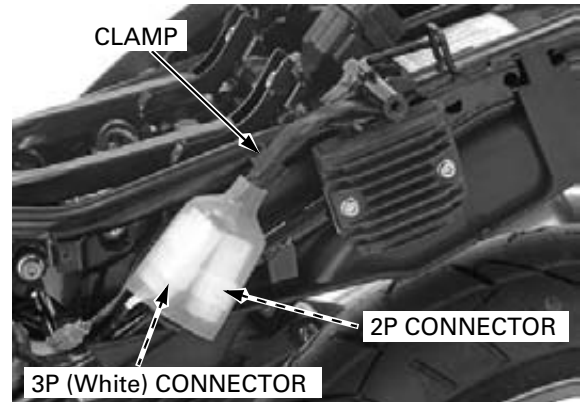

Remove the bolts, washers, collars and the regulator/rectifier with the spacer.

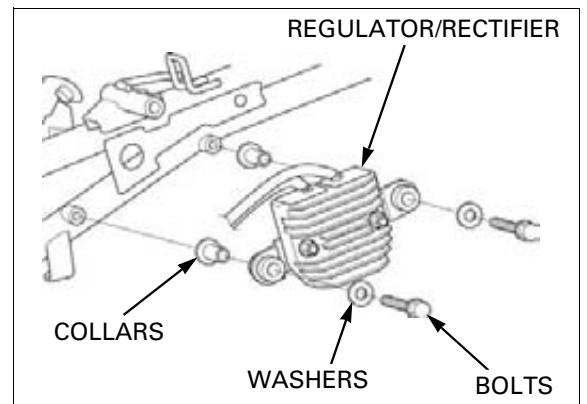

Remove the nuts and screws, then remove the spacer from the regulator/rectifier.

Install the regulator/rectifier in the reverse order of removal.

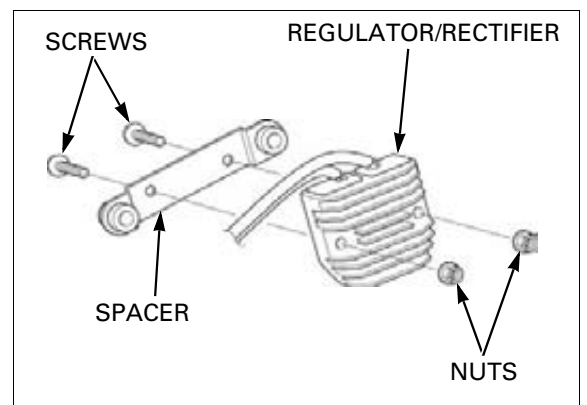

MEMO
