

# 7. COOLING SYSTEM

---

SYSTEM FLOW PATTERN .....	7-2	THERMOSTAT .....	7-8
SERVICE INFORMATION .....	7-3	RADIATOR .....	7-10
TROUBLESHOOTING .....	7-4	WATER PUMP .....	7-16
SYSTEM TESTING .....	7-5	RADIATOR RESERVE TANK .....	7-20
COOLANT REPLACEMENT .....	7-6	FAN CONTROL RELAY .....	7-21

# COOLING SYSTEM

## SYSTEM FLOW PATTERN

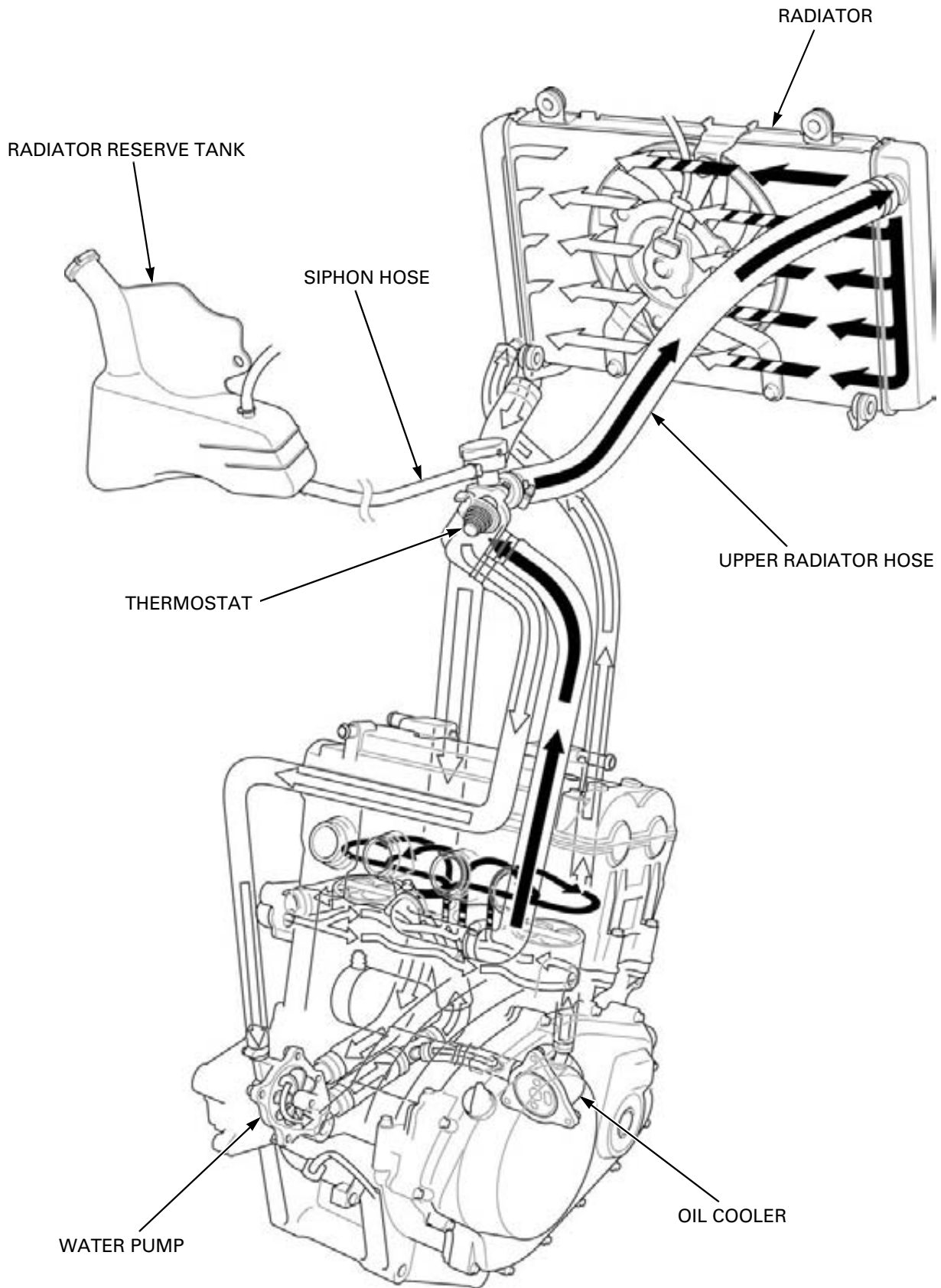

## SERVICE INFORMATION

### GENERAL

#### ⚠ WARNING

Removing the radiator cap while the engine is hot can allow the coolant to spray out, seriously scalding you. Always let the engine and radiator cool down before removing the radiator cap.

#### NOTICE

*Using coolant with silicate inhibitors may cause premature wear of water pump seals or blockage of radiator passages. Using tap water may cause engine damage.*

- Add cooling system at the reserve tank. Do not remove the radiator cap except to refill or drain the system.
- All cooling system services can be done with the engine installed in the frame.
- Avoid spilling coolant on painted surfaces.
- After servicing the system, check for leaks with a cooling system tester.
- Refer to the ECT sensor inspection (page 21-16).

### SPECIFICATIONS

ITEM		SPECIFICATIONS
Coolant capacity	Radiator and engine	2.71 liter (2.86 US qt, 2.38 Imp qt)
	Reserve tank	0.30 liter (0.32 US qt, 0.26 Imp qt)
Radiator cap relief pressure		108 – 137 kPa (1.1 – 1.4 kgf/cm <sup>2</sup> , 16 – 20 psi)
Thermostat	Begin to open	80 – 84 °C (176 – 183 °F)
	Fully open	90 °C (194 °F)
	Valve lift	8 mm (0.3 in) minimum
Recommended antifreeze		High quality ethylene glycol antifreeze containing corrosion protection inhibitors
Standard coolant concentration		1:1 mixture with distilled water

### TORQUE VALUES

Coolant drain bolt	12 N·m (1.2 kgf·m, 9 lbf·ft)	CT bolt
Water pump assembly bolt	12 N·m (1.2 kgf·m, 9 lbf·ft)	CT bolt
Cooling fan nut	2.7 N·m (0.3 kgf·m, 2.0 lbf·ft)	
Fan motor nut	5.1 N·m (0.5 kgf·m, 3.8 lbf·ft)	
Fan motor bracket mounting bolt	8.4 N·m (0.9 kgf·m, 6.2 lbf·ft)	

## COOLING SYSTEM

---

### TROUBLESHOOTING

#### Engine temperature too high

- Faulty ECT sensor
- Thermostat stuck closed
- Faulty radiator cap
- Insufficient coolant
- Passage blocked in radiator, hoses or water jacket
- Air in system
- Faulty cooling fan motor
- Faulty fan control relay
- Faulty water pump

#### Engine temperature too low

- Faulty ECT sensor
- Thermostat stuck open
- Faulty cooling fan control relay

#### Coolant leak

- Faulty water pump mechanical seal
- Deteriorated O-rings
- Faulty radiator cap
- Damaged or deteriorated cylinder head gasket
- Loose hose connection or clamp
- Damaged or deteriorated hose

# SYSTEM TESTING

## COOLANT (HYDROMETER TEST)

Lift and support the fuel tank (page 4-5).

Remove the radiator cap.

*Always let the engine and radiator cool down before removing the radiator cap.*



Test the coolant gravity using a hydrometer (see below for "Coolant gravity chart"). For maximum corrosion protection, a 1:1 solution of ethylene glycol and distilled water is recommended (page 7-3). Look for contamination and replace the coolant if necessary.

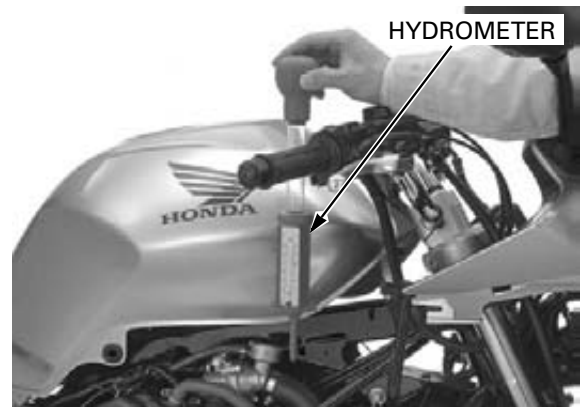

### COOLANT GRAVITY CHART

		Coolant temperature °C (°F)										
		0 (32)	5 (41)	10 (50)	15 (59)	20 (68)	25 (77)	30 (86)	35 (95)	40 (104)	45 (113)	50 (122)
Coolant ratio%	5	1.009	1.009	1.008	1.008	1.007	1.006	1.005	1.003	1.001	0.999	0.997
	10	1.018	1.017	1.017	1.016	1.015	1.014	1.013	1.011	1.009	1.007	1.005
	15	1.028	1.027	1.026	1.025	1.024	1.022	1.020	1.018	1.016	1.014	1.012
	20	1.036	1.035	1.034	1.033	1.031	1.029	1.027	1.025	1.023	1.021	1.019
	25	1.045	1.044	1.043	1.042	1.040	1.038	1.036	1.034	1.031	1.028	1.025
	30	1.053	1.052	1.051	1.047	1.046	1.045	1.043	1.041	1.038	1.035	1.032
	35	1.063	1.062	1.060	1.058	1.056	1.054	1.052	1.049	1.046	1.043	1.040
	40	1.072	1.070	1.068	1.066	1.064	1.062	1.059	1.056	1.053	1.050	1.047
	45	1.080	1.078	1.076	1.074	1.072	1.069	1.066	1.063	1.060	1.057	1.054
	50	1.086	1.084	1.082	1.080	1.077	1.074	1.071	1.068	1.065	1.062	1.059
	55	1.095	1.093	1.091	1.088	1.085	1.082	1.079	1.076	1.073	1.070	1.067
	60	1.100	1.098	1.095	1.092	1.089	1.086	1.083	1.080	1.077	1.074	1.071

## COOLING SYSTEM

### RADIATOR CAP/SYSTEM PRESSURE INSPECTION

Remove the radiator cap (page 7-5).

*Before installing the cap in the tester, wet the sealing surfaces.*

Pressure test the radiator cap. Replace the radiator cap if it does not hold pressure, or if relief pressure is too high or too low. It must hold specified pressure for at least 6 seconds.

#### RADIATOR CAP RELIEF PRESSURE:

**108 – 137 kPa (1.1 – 1.4 kgf/cm<sup>2</sup>, 16 – 20 psi)**

Pressure the radiator, engine and hoses, and check for leaks.

#### NOTICE

*Excessive pressure can damage the cooling system components. Do not exceed 137 kPa (1.4 kgf/cm<sup>2</sup>, 20 psi).*

Repair or replace components if the system will not hold specified pressure for at least 6 seconds.

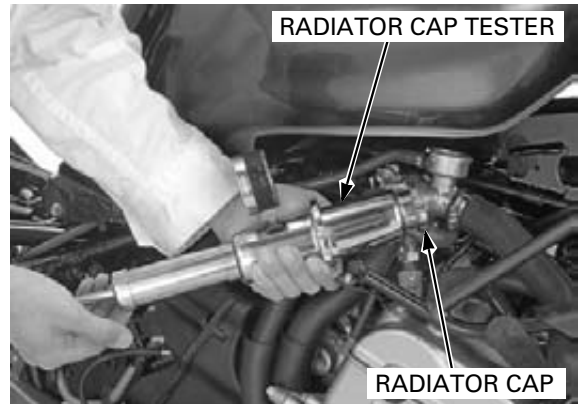

## COOLANT REPLACEMENT

### PREPARATION

- The effectiveness of coolant decreases with the accumulation of rust or if there is a change in the mixing proportion during usage. Therefore, for best performance change the coolant regularly as specified in the maintenance schedule.
- Mix only distilled water with the antifreeze.

#### RECOMMENDED ANTIFREEZE:

**High quality ethylene glycol antifreeze containing corrosion protection inhibitors**

#### RECOMMENDED MIXTURE:

**1:1 (distilled water and antifreeze)**

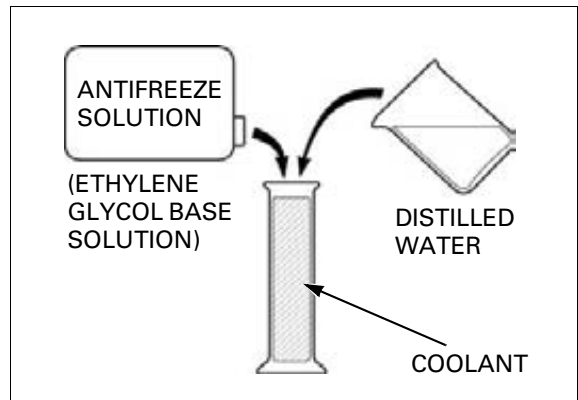

**REPLACEMENT/AIR BLEEDING**

Lift and support the fuel tank (page 4-5).

Remove the radiator cap.

*Always let the engine and radiator cool down before removing the radiator cap.*

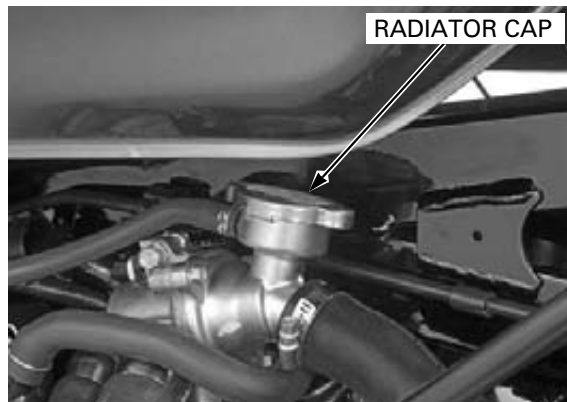

Remove the drain bolt on the water pump cover and drain the system coolant.

Reinstall the drain bolt with new sealing washer. Tighten the water pump drain bolt to the specified torque.

**TORQUE: 12 N·m (1.2 kgf·m, 9 lbf·ft)**

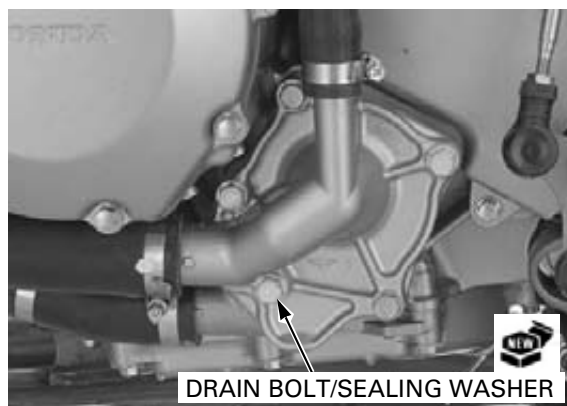

Remove the battery (page 18-6).

Release the siphon hose from the clamp and disconnect it from the hose joint, then drain the coolant. Empty the coolant and rinse the inside of the reserve tank with water.

Connect the siphon hose and secure it with the clamp.

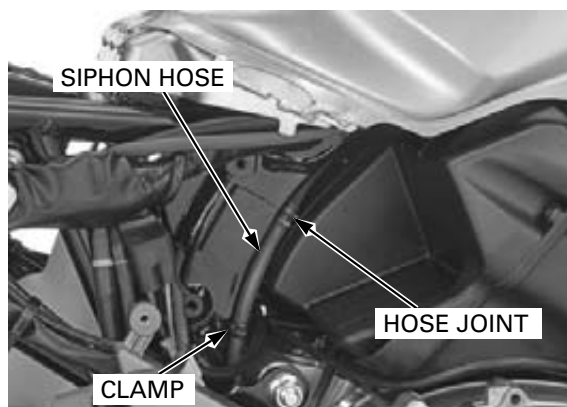

Remove the radiator reserve tank cap and fill the reserve tank to the upper level line.

Bleed air from the system as follows:

1. Shift the transmission into neutral. Start the engine and let it idle for 2 – 3 minutes.
2. Snap the throttle three to four times to bleed air from the system.
3. Stop the engine and add coolant up to the proper level if necessary. Reinstall the radiator cap.
4. Check the level of coolant in the reserve tank and fill to the upper level if it is low.

Install the radiator reserve tank cap.

Lower the fuel tank and install the front mounting bolts (page 4-5).

Install the removed parts in the reverse order.



*When filling the system or reserve tank with a coolant (checking coolant level), place the motorcycle in a vertical position on a flat, level surface.*

## COOLING SYSTEM

### THERMOSTAT

#### REMOVAL

Drain the coolant (page 7-7).

Disconnect the crankcase breather hose from the air cleaner housing, and siphon hose from thermostat case.

Remove the thermostat case mounting bolt.

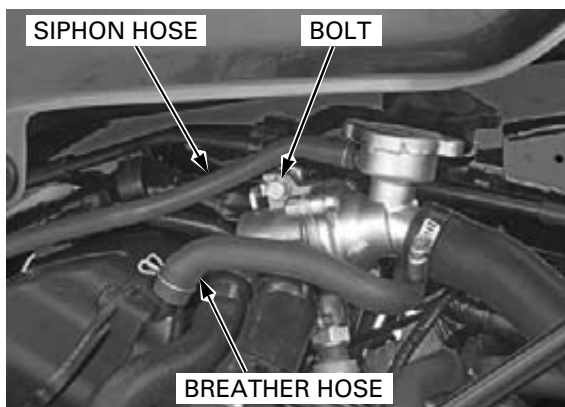

Remove the filler neck bolts.

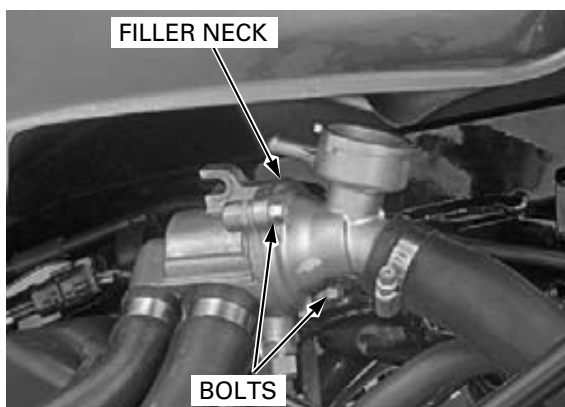

Remove the thermostat from the case.

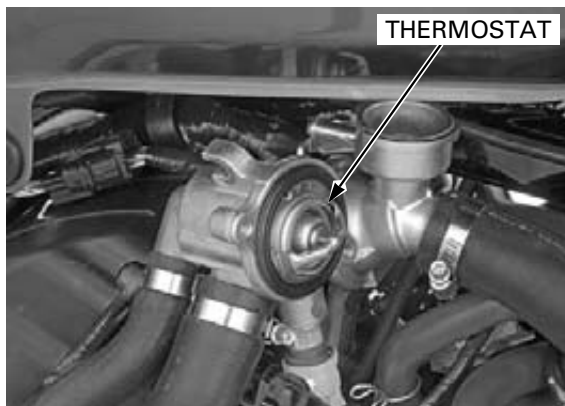

#### INSPECTION

Visually inspect the thermostat for damage. Check for damage of the seal ring.

Replace the thermostat if the valve stays open at room temperature.

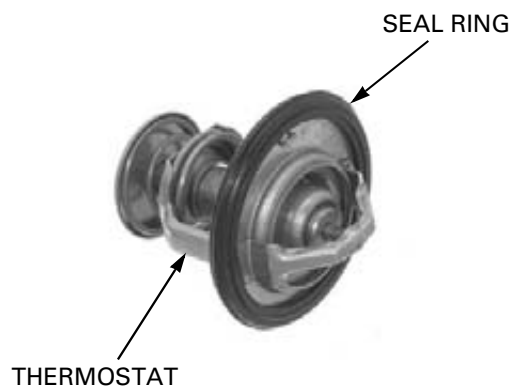



**NOTICE**

- Wear insulated gloves and adequate eye protection.
- Keep flammable materials away from the electric heating element.

*Do not let the thermostat or thermometer touch the pan, or you will get false reading.*

Heat the water with an electric heating element to operating temperature for 5 minutes. Suspend the thermostat in heated water to check its operation.

**THERMOSTAT BEGIN TO OPEN:**  
**80 – 84 °C (176 – 183 °F)**

**VALVE LIFT:**  
**8 mm (0.3 in) minimum at 95 °C (203 °F)**

Replace the thermostat if the valve responds at temperatures other than those specified.

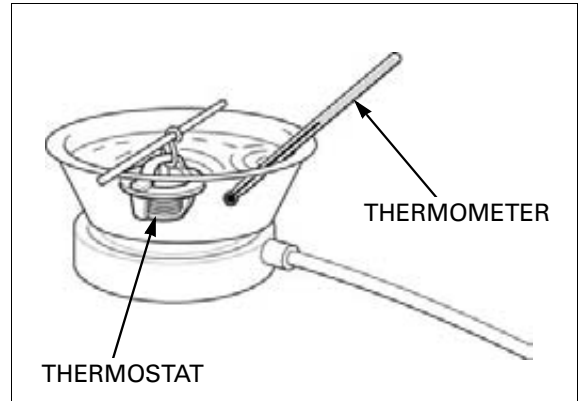

**THERMOSTAT INSTALLATION**

Install the thermostat into the case with its air bleed hole facing upward.

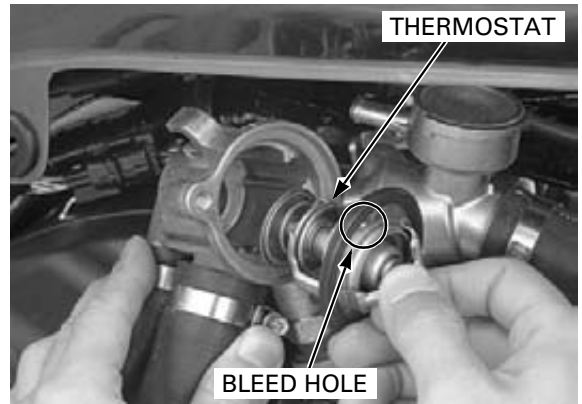

Install the filler neck onto the thermostat case. Install and tighten the filler neck bolts securely.

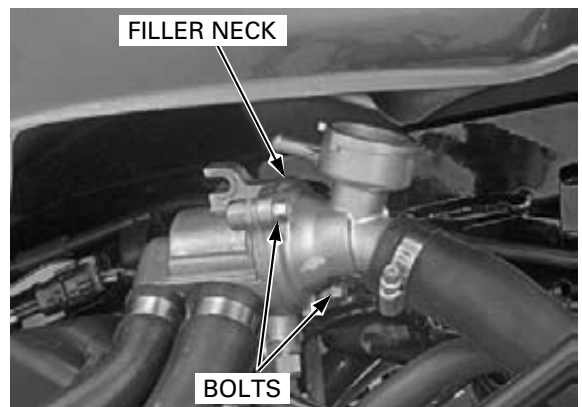

## COOLING SYSTEM

Install the thermostat case onto the frame.

Route the crankcase breather hose properly and connect it to the air cleaner housing.

Connect the siphon hose to the filler neck.

Fill the system with the recommended coolant and bleed any air (page 7-6).

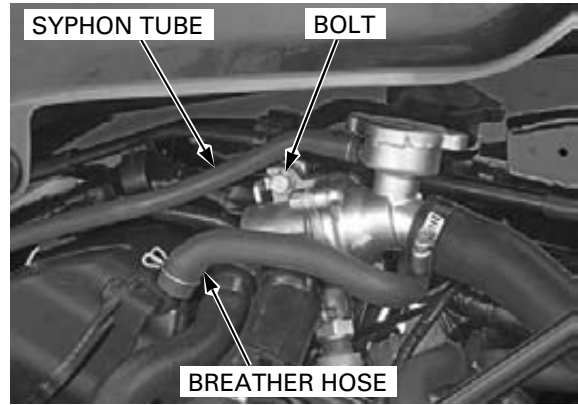

### THERMOSTAT CASE REMOVAL/ INSTALLATION

Drain the coolant (page 7-7).

Disconnect the crankcase breather hose.  
Remove the thermostat case mounting bolt.

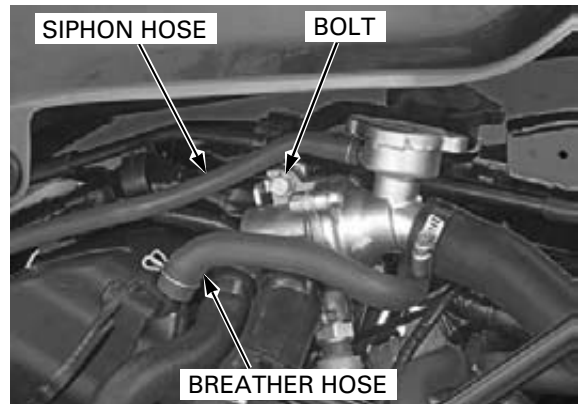

Disconnect the ECT sensor connector.  
If necessary, remove the ECT sensor from the thermostat case (page 21-16).

Loosen the hose band screws and disconnect the water hoses from the thermostat case.

Installation is in the reverse order of removal.

Fill the system with the recommended coolant and bleed any air (page 7-6).

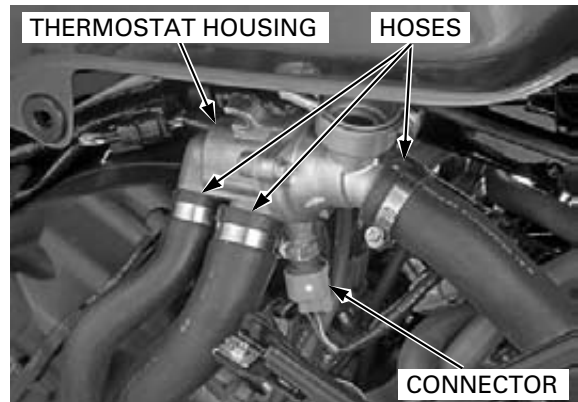

## RADIATOR

### REMOVAL

Lift and support the fuel tank (page 4-5).

Drain the coolant (page 7-7).

Disconnect the fan motor 2P (Black) connector.

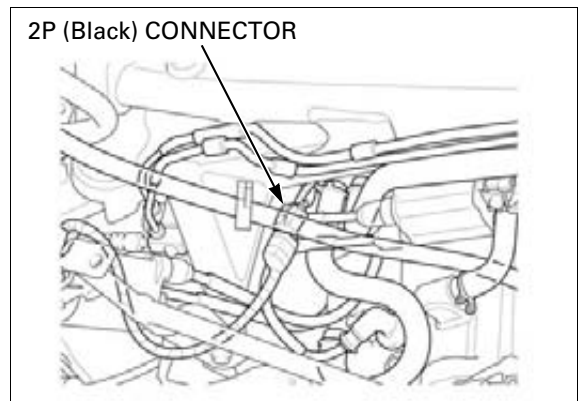

Loosen the hose band screws and disconnect the radiator lower hose and water hose.

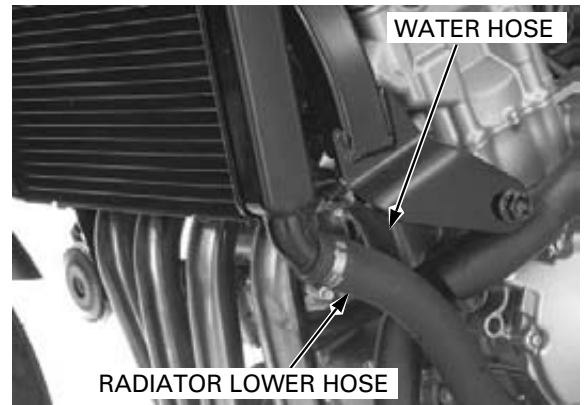

Loosen the hose band screw and disconnect the radiator upper hose.



Remove the radiator upper mounting bolt and washer.  
Unhook the heat guard rubber from the front left cowl stay boss.

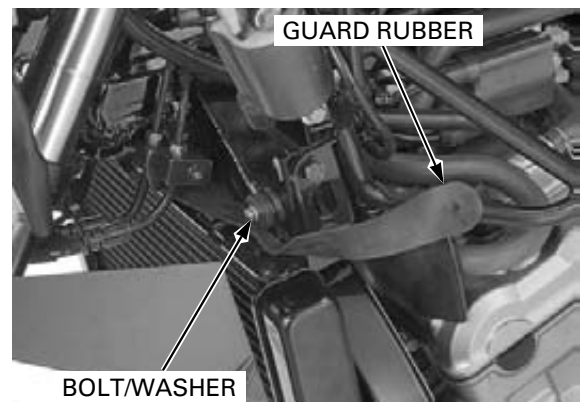

Remove the radiator upper mounting bolt and washer.

Unhook the heat guard rubber from the front right cowl stay bosses.

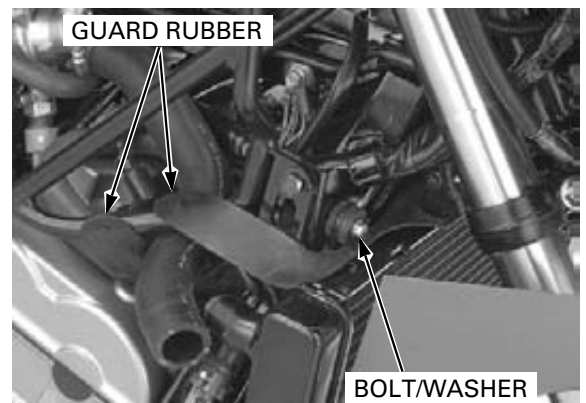

## COOLING SYSTEM

*Be careful not to damage the radiator fins.* Slide the radiator assembly and release the radiator lower grommets from the frame bosses, then remove the radiator assembly.

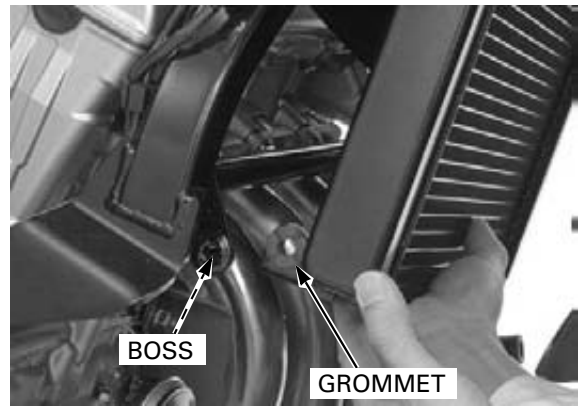

### DISASSEMBLY

Remove the heat guard rubber from the radiator assembly.

HEAT GUARD RUBBER

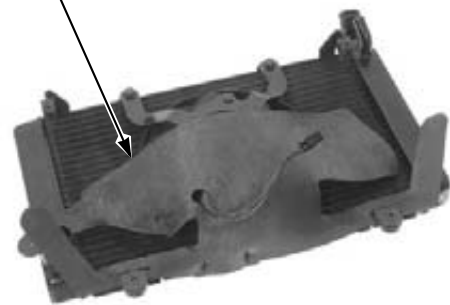

Remove the three bolts and cooling fan motor assembly from the radiator.

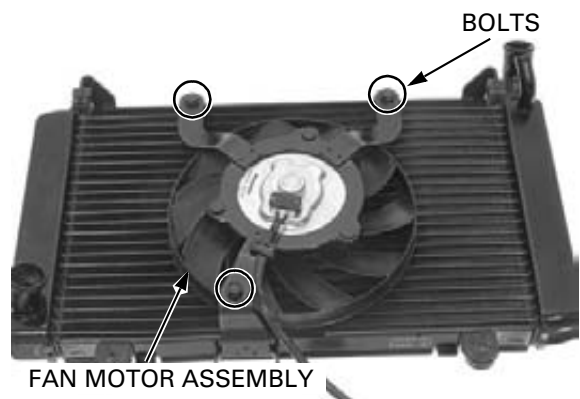

Remove the nut and cooling fan.

COOLING FAN

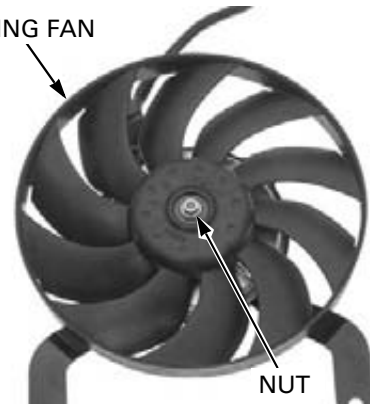

Release the fan motor wire from the wire clamp.  
Remove the nuts and fan motor from the fan motor bracket.  
Refer to the fan control relay information (page 7-21).

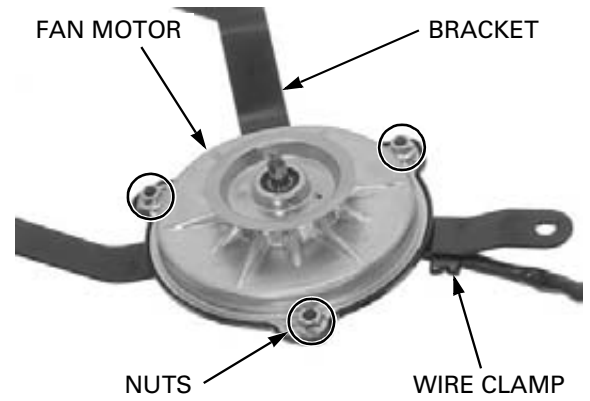

## ASSEMBLY

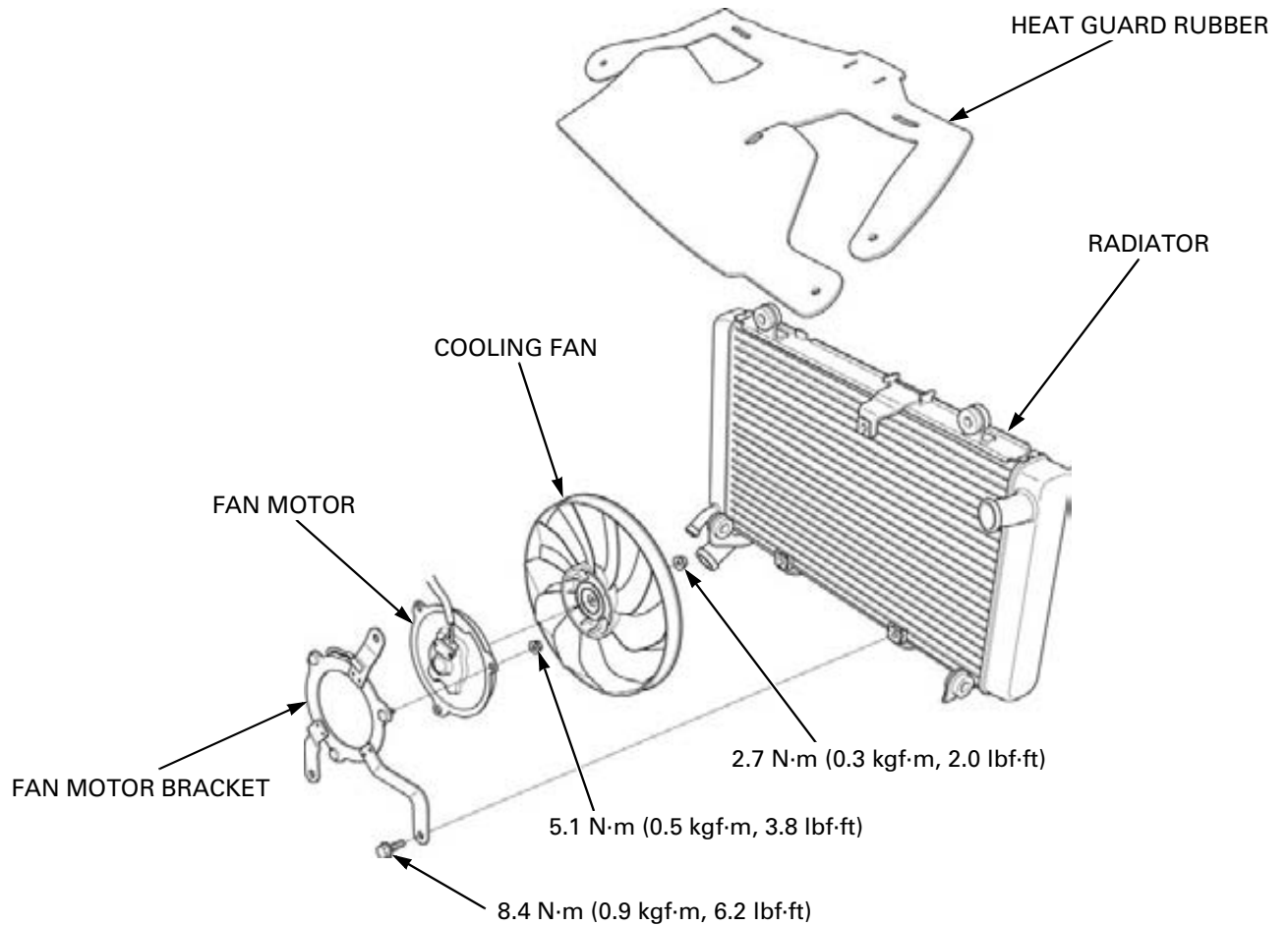

Install the fan motor onto the fan motor bracket and tighten the nuts to the specified torque.

**TORQUE: 5.1 N·m (0.5 kgf·m, 3.8 lbf·ft)**

Secure the fan motor wire with the wire clamp

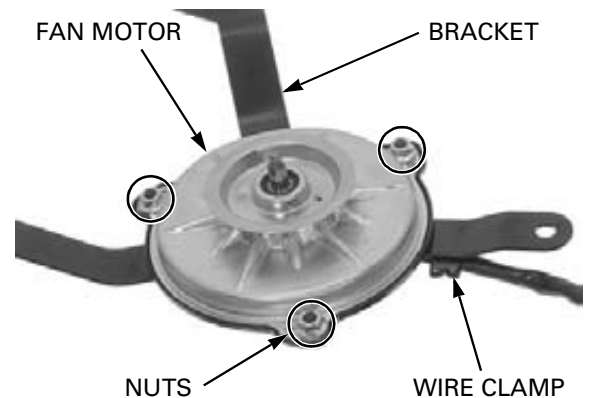

## COOLING SYSTEM

Install the cooling fan onto the fan motor shaft by aligning the flats with each other.

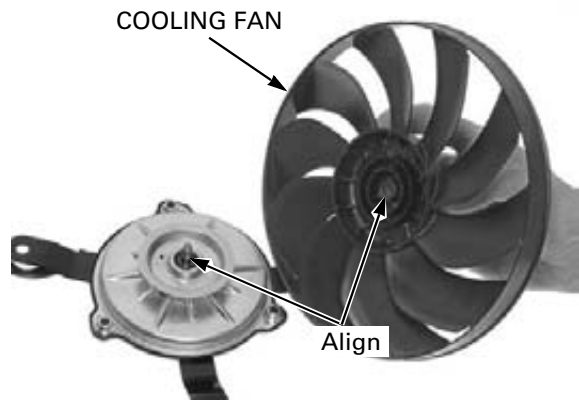

Apply a locking agent to the cooling fan nut threads. Install and tighten the nut to the specified torque.

**TORQUE: 2.7 N·m (0.3 kgf·m, 2.0 lbf·ft)**

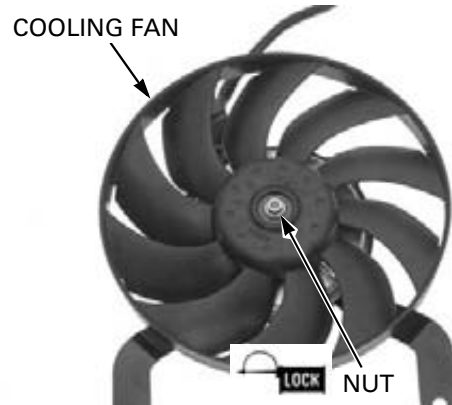

Install the fan motor assembly onto the radiator. Install and tighten the three bolts to the specified torque.

**TORQUE: 8.4 N·m (0.9 kgf·m, 6.2 lbf·ft)**

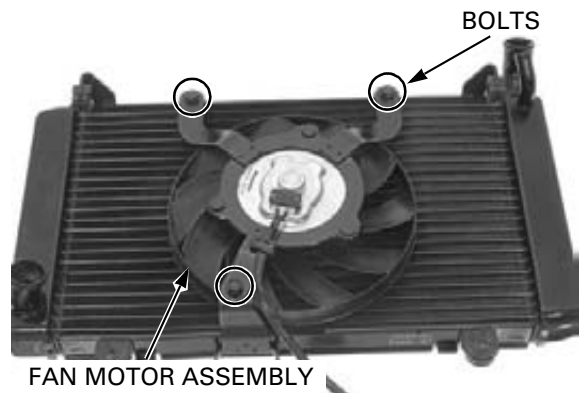

*Set the radiator tabs in the protector cut-outs, also set the radiator bosses in the protector holes.*

Route the fan motor wire through the hole of the heat guard rubber and install the protector on the radiator.

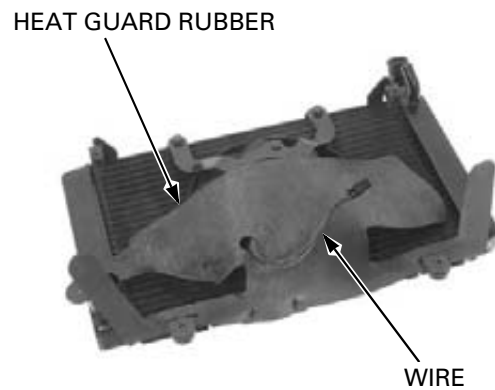

**INSTALLATION**

*Be careful not to damage the radiator fins.*

Align the radiator lower grommets with the frame bosses and install the radiator assembly.

Spread the heat guard rubber on the cylinder head cover.

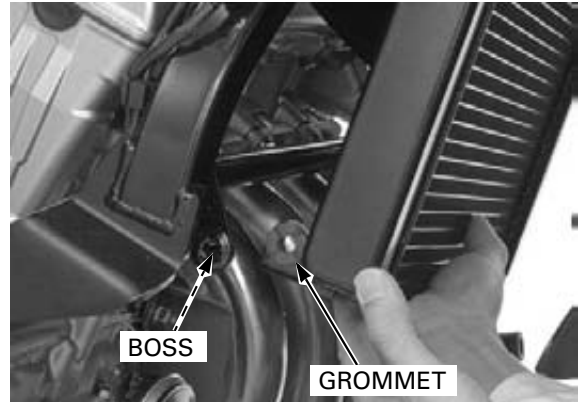

Install the washer and radiator upper mounting bolt, and tighten the bolt securely.

Hook the heat guard rubber on the side cowl stay boss.

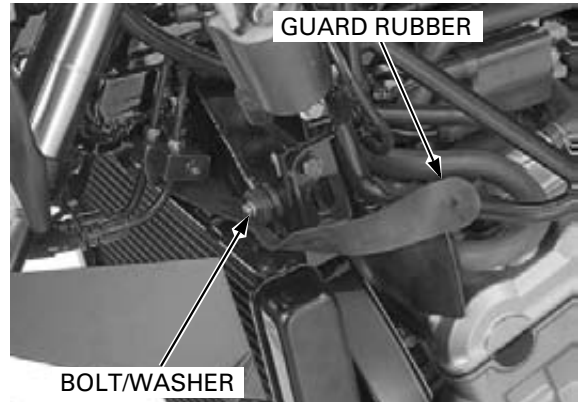

Install the washer and radiator upper mounting bolt, and tighten the bolt securely.

Hook the heat guard rubber on the side cowl stay bosses.

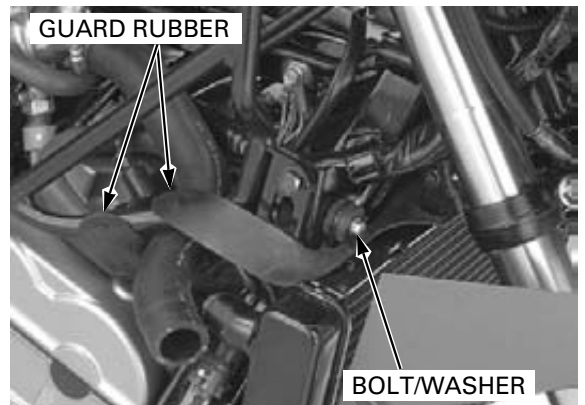

Connect the water hose and radiator lower hose. Tighten the hose band screws securely.

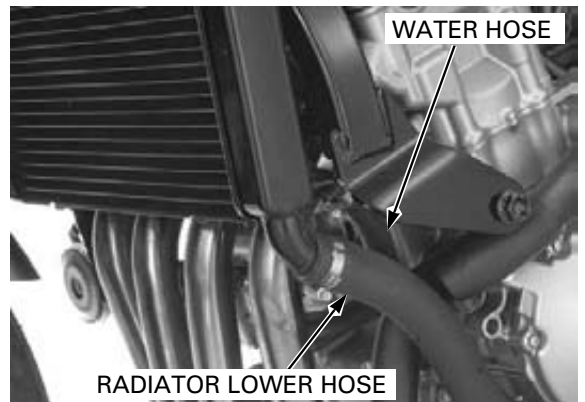

## COOLING SYSTEM

Connect the radiator upper hose and tighten the hose band screw securely.



Route the fan motor wire properly and connect the fan motor 2P (Black) connector.

Fill the system with the recommended coolant (page 7-6).

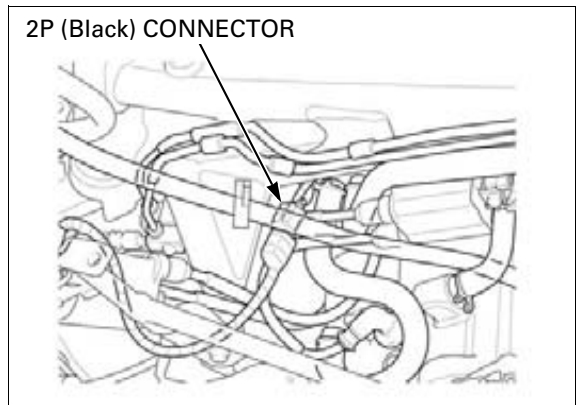

## WATER PUMP

### MECHANICAL SEAL INSPECTION

Inspect the inspection hole for signs of coolant leakage.

If there is leakage, the mechanical seal is defective and replace the water pump as an assembly.

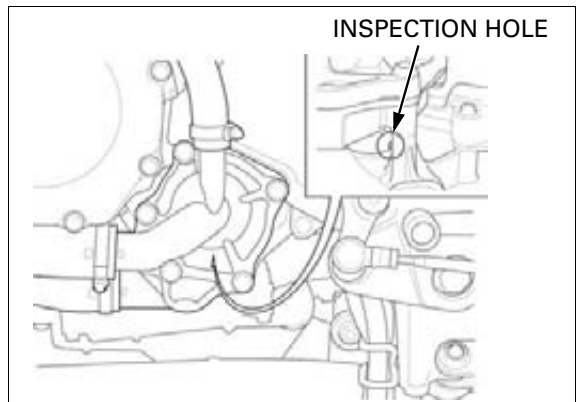

### REMOVAL

Drain the coolant (page 7-7).

Disconnect the radiator lower hose and bypass hose from the water pump cover.

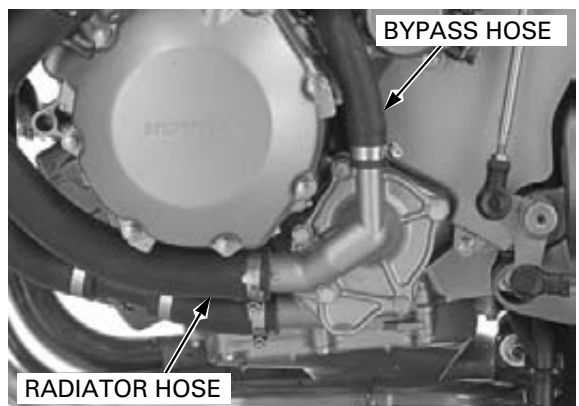



Remove the flange bolts, drain bolt and sealing washer.

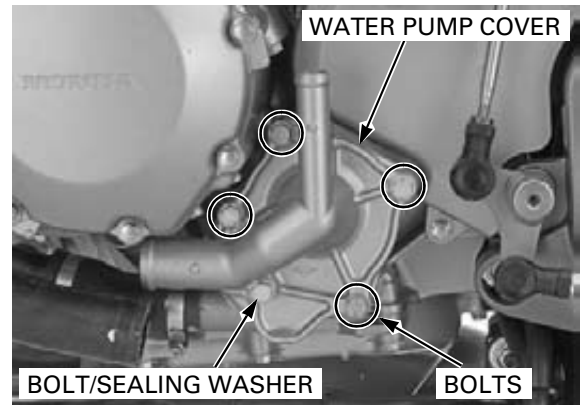

Remove the water pump cover assembly  
Remove the O-ring from the water pump body.

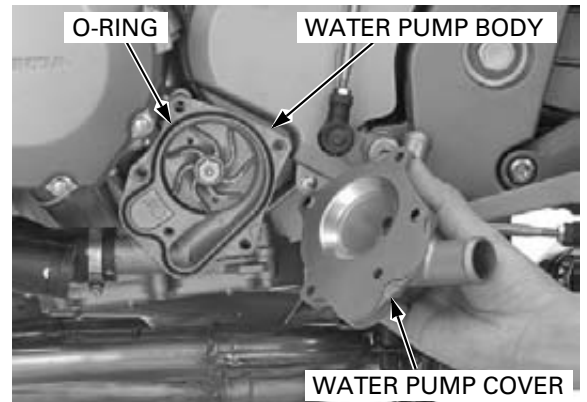

Remove the separator plate from the water pump cover.  
Remove the dowel pins and O-ring from the water pump cover.

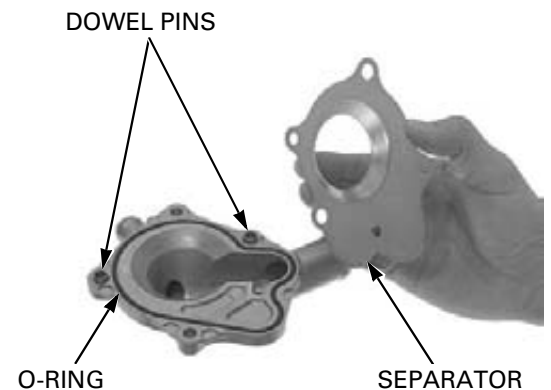

Disconnect the water joint hose from the water pump body.  
Remove the water pump body from the crankcase.

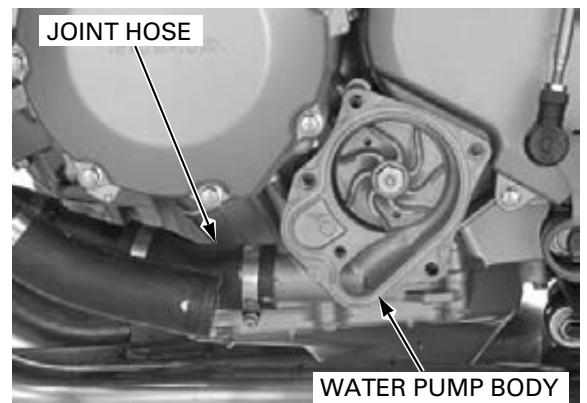

# COOLING SYSTEM

## INSTALLATION

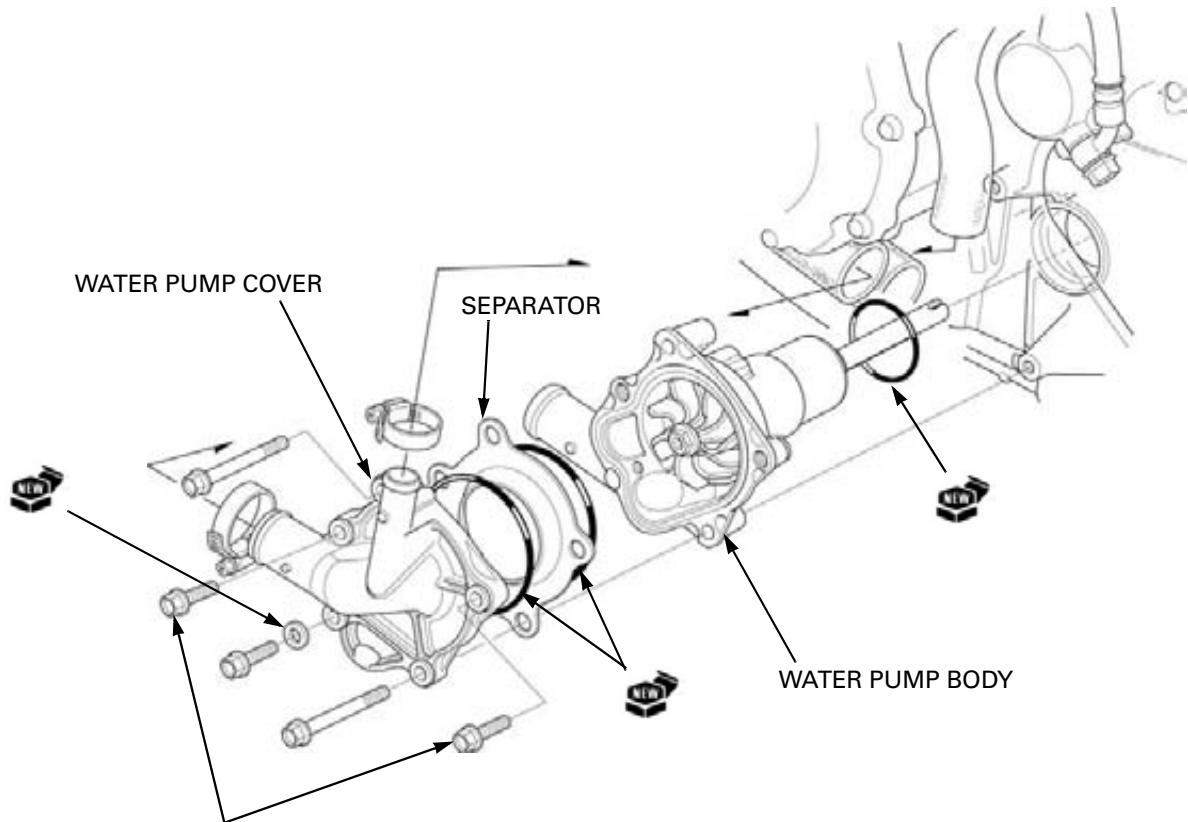

12 N·m (1.2 kgf·m, 9 lbf·ft)

Apply engine oil to new O-ring and install it onto the stepped portion of the water pump body.

Install the water pump body into the crankcase while aligning the water pump shaft groove with the oil pump shaft end.

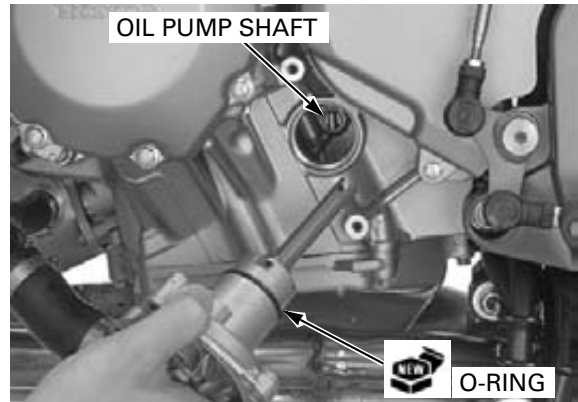

Align the water pump shaft groove with the oil pump shaft end by turning the water pump impeller.

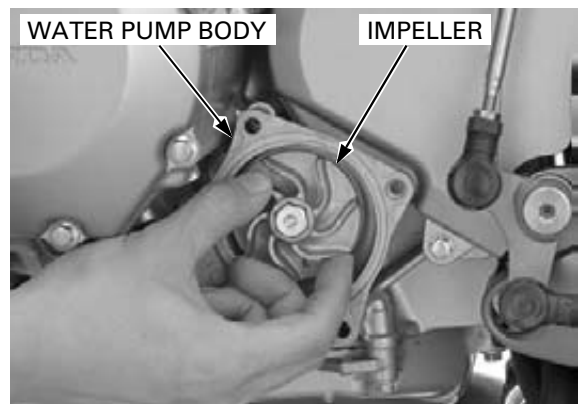

Align the mounting bolt holes in the water pump and crankcase, and make sure the water pump is securely installed.

Connect the joint hose to the water pump body, and tighten the hose band screw.

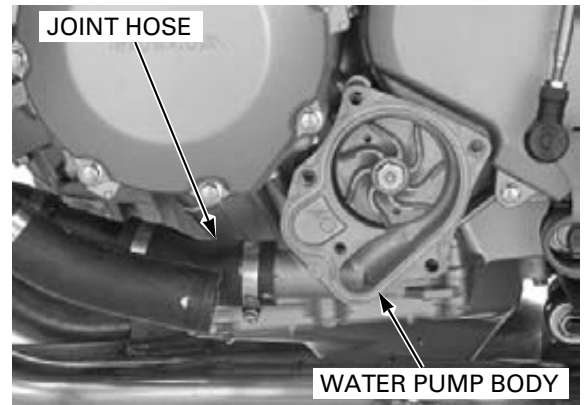

Install a new O-ring into the groove in the water pump cover.

Install the dowel pins.

Install the separator onto the water pump cover.

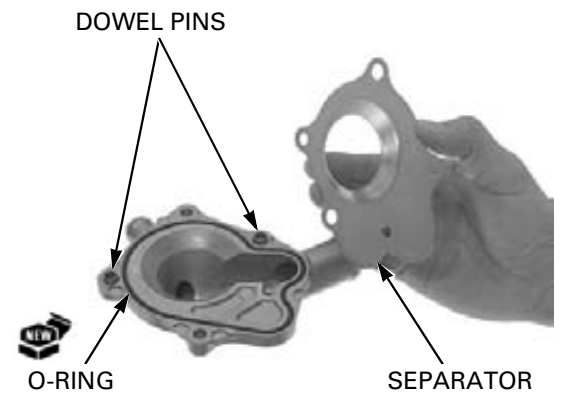

Install a new O-ring into the water pump body groove.

Install the water pump cover assembly onto the water pump body.

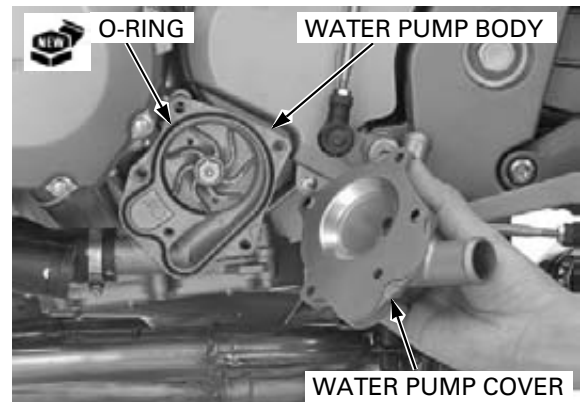

Install the water pump cover bolts and drain bolt with new sealing washer.

Tighten the bolts to the specified torque.

**TORQUE: 12 N·m (1.2 kgf·m, 9 lbf·ft)**

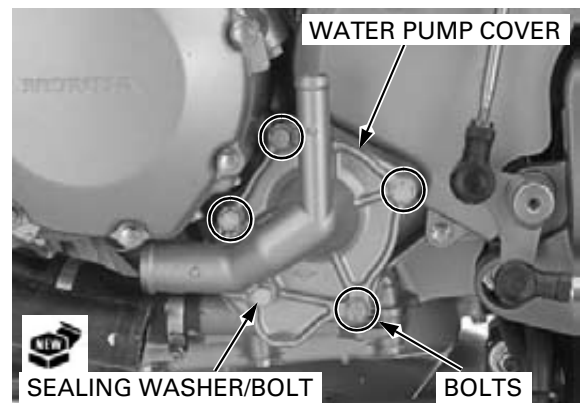

## COOLING SYSTEM

Connect the radiator lower hose and bypass hose, then tighten the hose band screws.

Fill the system with the recommended coolant (page 7-6).

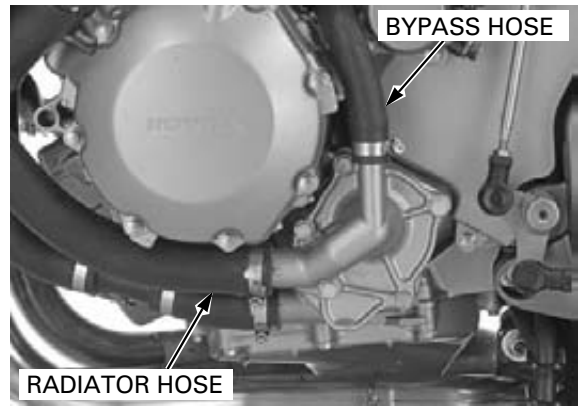

## RADIATOR RESERVE TANK

### REMOVAL

Remove the following:

- Shock absorber (page 15-13)
- Battery (page 18-6)

Release the siphon hose from the clammer and disconnect it from the hose joint, then drain the coolant.

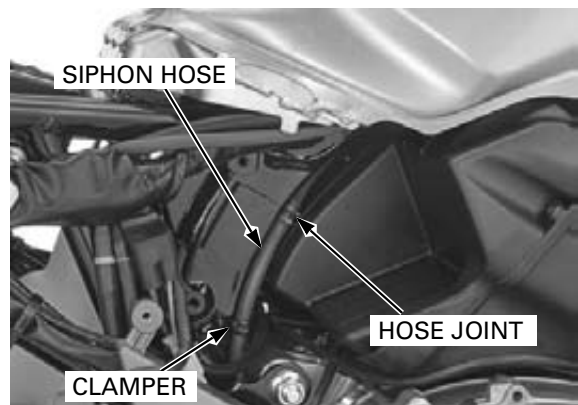

Remove the bolts and radiator reserve tank.  
Installation is in the reverse order of removal.

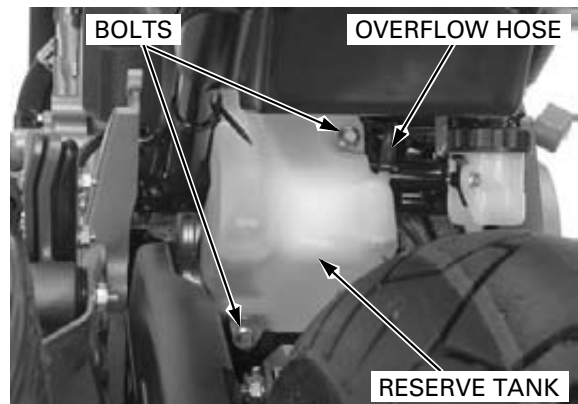

- Secure the siphon hose and reserve tank overflow hose with the frame clammer as shown.

Fill the reserve tank with coolant (page 7-7).

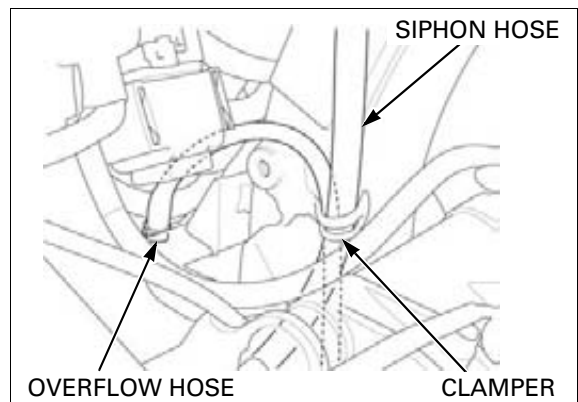

## FAN CONTROL RELAY

### INSPECTION

Remove the right rear cowl (page 3-8).  
Remove the relay box from the bracket.

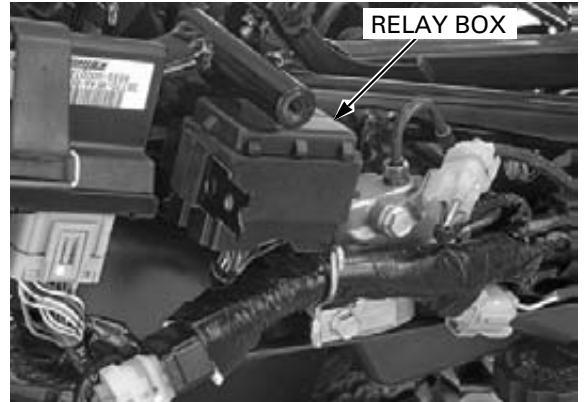

Release the retainers and remove the relay connector (Brown).

Remove the fan control relay from the connector.

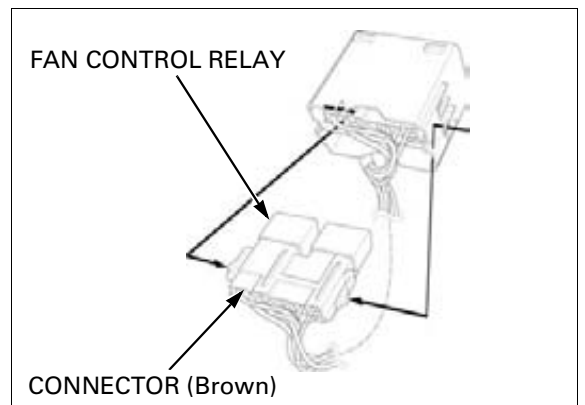

Connect the ohmmeter to the fan control relay connector terminals.

**Connection: A (Red/green) – B (Black/blue)**

Connect a 12 V battery to the following engine stop relay connector terminals.

**Connection: C (Black/white) – D (Green/blue)**

There should be continuity only when the 12 V battery is connected.

If there is no continuity when the 12 V battery is connected, replace the fan control relay.

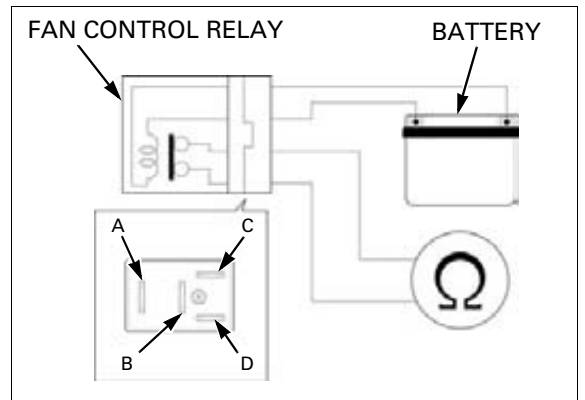

---

**MEMO**

---